

df6na@df6na.de / df6na@df6na.mayn.de

2 kW
Power Amplifier
for
144 Mhz
using
GU84b
tube

by

Paul Chominski WA6PY

<http://www.df6na.de> - <http://df6na.mayn.de>

2 kW Power Amplifier for 144 MHz using GU84B tube.

March 10, 2000

Paul Chominski WA6PY
17433 Gibraltar Ct
San Diego, CA 92128, USA

1. General

Amplifier is build in home made aluminum compartment which must be electrically tight in order to avoid RF radiation. RF radiation will decrease output power and can cause self oscillations of the transmitter chain and health risk.

2. Tube socket

I used original tube socket. I removed cathode resistors and shorted cathode connections to the ground providing as low parasitic inductance as possible.

In order to decrease RF loss and leakage from anode resonator to the grid input circuit through the socket. I soldered additional grounding strips to the top cover of the grid 2 bypass capacitors of the socket (Fig.1.).

Grid 2 bypass capacitor consist of six flat ceramic capacitors. Parameters of this bypass capacitor has been measured by means of network analyzer. First series resonance is on 14.7 MHz. At 144 MHz bypass capacitor can be represented as series connection of $C=22$ nF $L=7.73$ nH $R=0.1$ ohm.

Parasitic inductance and resistance produce essential feedback into the input of the amplifier. Resistance increase output losses because high current flowing from the anode through Cag2 is causing power loss dissipated in this parasitic resistance. Computer simulations indicated that reverse isolation of the amplifier can be -35 dB using grid 1 load resistor of 200 ohms and $G=15$ dB. This makes 20 dB stability margin.

Simulations what will change adding $\frac{1}{4}$ wavelength open line as additional grid 2 bypass capacitor in order to improve isolation and decrease output circuit losses indicate potential instability of the amplifier in 110 MHz range.

3. Input circuit

Tube is driven in grid 1 with grounded cathode. Grid 1 is loaded with 200 ohm RF power resistor in order to decrease gain and increase stability factor. The original socket of the tube and internal structure of the tube represents high series inductance. This inductance is used as a part of the series input matching inductor. Loading resistor is

connected on the “way” between grid 1 and resonance tuning capacitor of the matching circuit due to this parasitic inductance of the tube plus tube socket.

4. Output circuit

Output resonator is based on W6PO design.

Due to the high output capacitance of the tube losses in the output tank are high. Tuning for resonance should be done by changing length of the resonators rather than increasing C_t tuning capacitor.

Output capacitor has higher value than in the amplifiers operating at higher anode voltage and lower current. $C_o = 5.. \text{ pF}$

On the outside of the anode resonator compartment additional $\frac{1}{4}$ wavelength shorted end line is connected in order to provide DC shortage in case of arcing in the output capacitor. This shorted line will provide additional attenuation of even harmonics. Output of high power amplifier should always be filtered by means of low pass filter. I am using low pass filter designed and made by SM6FHZ and distributed by Ben SM6CKU – Parabolic. Another filters has been described in past DUBUS [3].

5. Power Supply, Bias and protection circuit

Heater is switched through time delay in order to minimize high inrush current and thermal stress.

Grid 1 bias voltage is regulated. Grid 1 is switched to -150 V for RX conditions.

Grid 2 supply is simplified. Voltage is switched using electromechanical relay when protection circuit allows. Grid 2 is shorted to the ground for RX mode and is using ballast resistor in case of negative grid 2 current.

Description of anode voltage supply is not provided in this paper. Voltage should be fairly stable for load conditions. It is desire to limit unloaded V_a to 2.4 kV and provide $V_a = 2$ to 2.2 kV under full load $I_a = 2.4 \text{ A}$.

Protection circuitry will allow switching to TX mode when following conditions are met:

$PTT = 0 \text{ V}$

$V_{g1} < -30 \text{ V}$

$V_{g2} > 250 \text{ V}$

$V_a > 1.3 \text{ kV}$

Protection will switch bias conditions for TX and send out PTT_ACKN signal which should be used to control driver, transceiver (PTT) and LNA sequencer switching between RX – TX.

6. Cooling

Cold air inlet is located in to the input compartment. Air flows through the tube socket cooling heater terminals, tube body and anode cooling fins. Hot air outlet is located above the tubes anode cooling fins.

7. Tuning amplifier

First tuning should be done with the tube inserted but without any voltage applied. Tubes capacitances are going to be the same, except for some changes due to the Miller effect. Input circuit is terminated by 100 ohm non inductive resistor. Tuning the input resonance circuit should be done using VSWR meter connected between driver and input.

Output coupling capacitor should be set as on the schematic to about 5.5 pF. Output should be connected to the diode detector or another power meter. When input is tuned to the minimum VSWR, driver power can be increased to 30 W = 44.8 dBm. Assuming reverse isolation – 34 dB it should be at the output +10.8 dBm = 11.9 mW. This power should be easy measured by diode detector. Now, output resonator should be tuned for maximum output power measured at the output connector.

Before any high voltage will be applied to the tube, tube should be run on heater for several hours especially if the tube wasn't use for log time [2]. From this point of time, cooling must be operational. Having heater voltage connected to the tube without adequate cooling will damage the tube.

Next anode voltage should be applied and idle conditions of the amplifier checked. Then low drive power producing no more than $I_a = 200$ to 300 mA should be applied and anode resonator should be tuned for max output power by adjusting length of the resonator lines (tubes). Then the power can be gradually increased until full power, making corrections to the tuning and checking I_{g1} , I_{g2} and I_a .

8. Results

Reverse isolation = -34 dB and Gain 15 dB depending on power level.

Tube is sensitive to the grid 2 voltage. This voltage should be from 350 to 400 V. If the voltage is to low, anode current will be low and grid1 and grid 2 currents will be to high. Higher than factory specified grid2 voltage is not recommended, because of possible damage to the tube.

Anode power supply was not stable enough to produce 2000 to 2100 V under load , and this reflects in lower output power than expected.

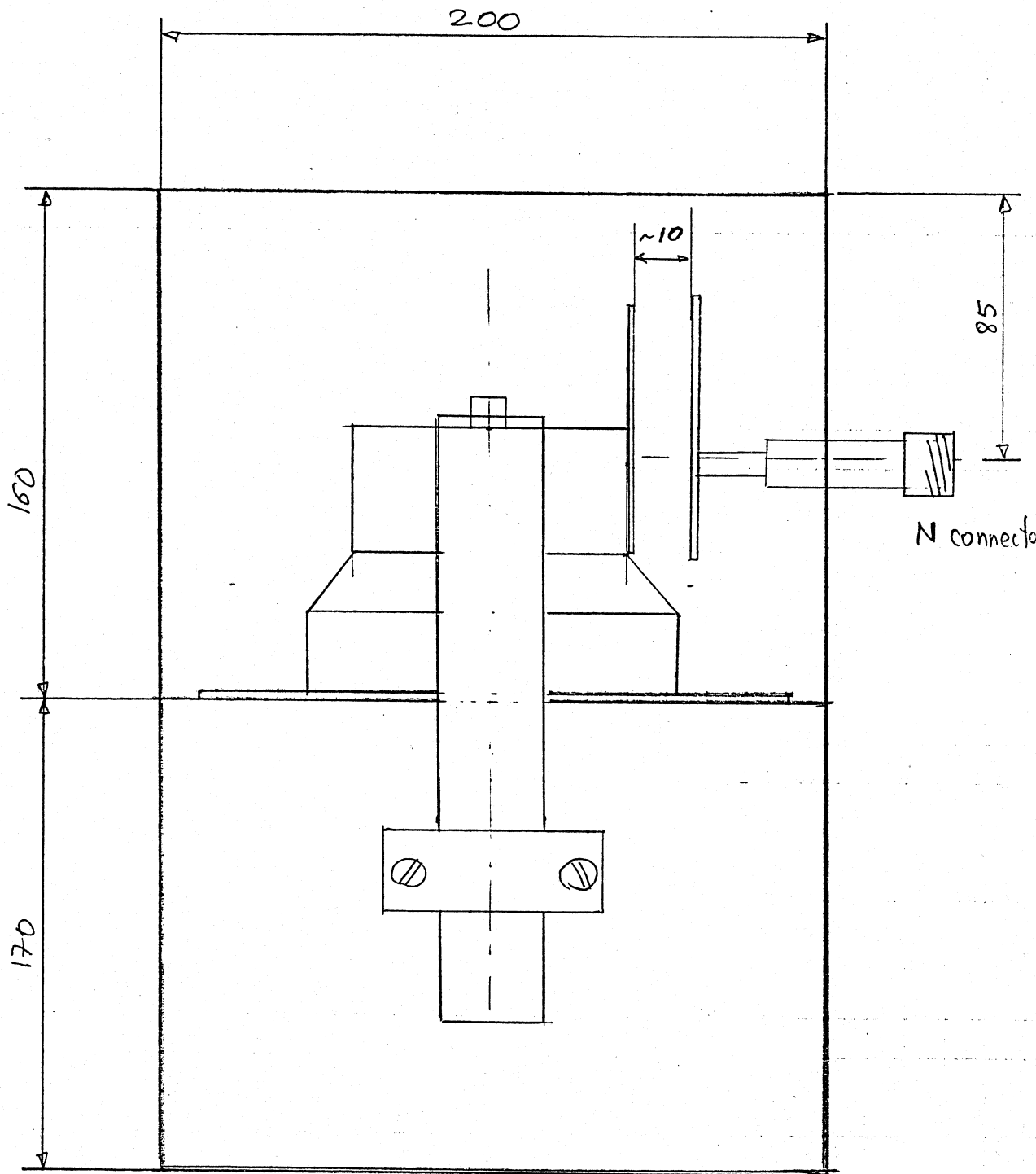

P_{out} N type
 C_{out}

$5 pF \Rightarrow S = 56 cm^2 \quad d = 1 cm$
 $6,6 pF \Rightarrow S = 75 cm^2 \quad d = 1 cm$

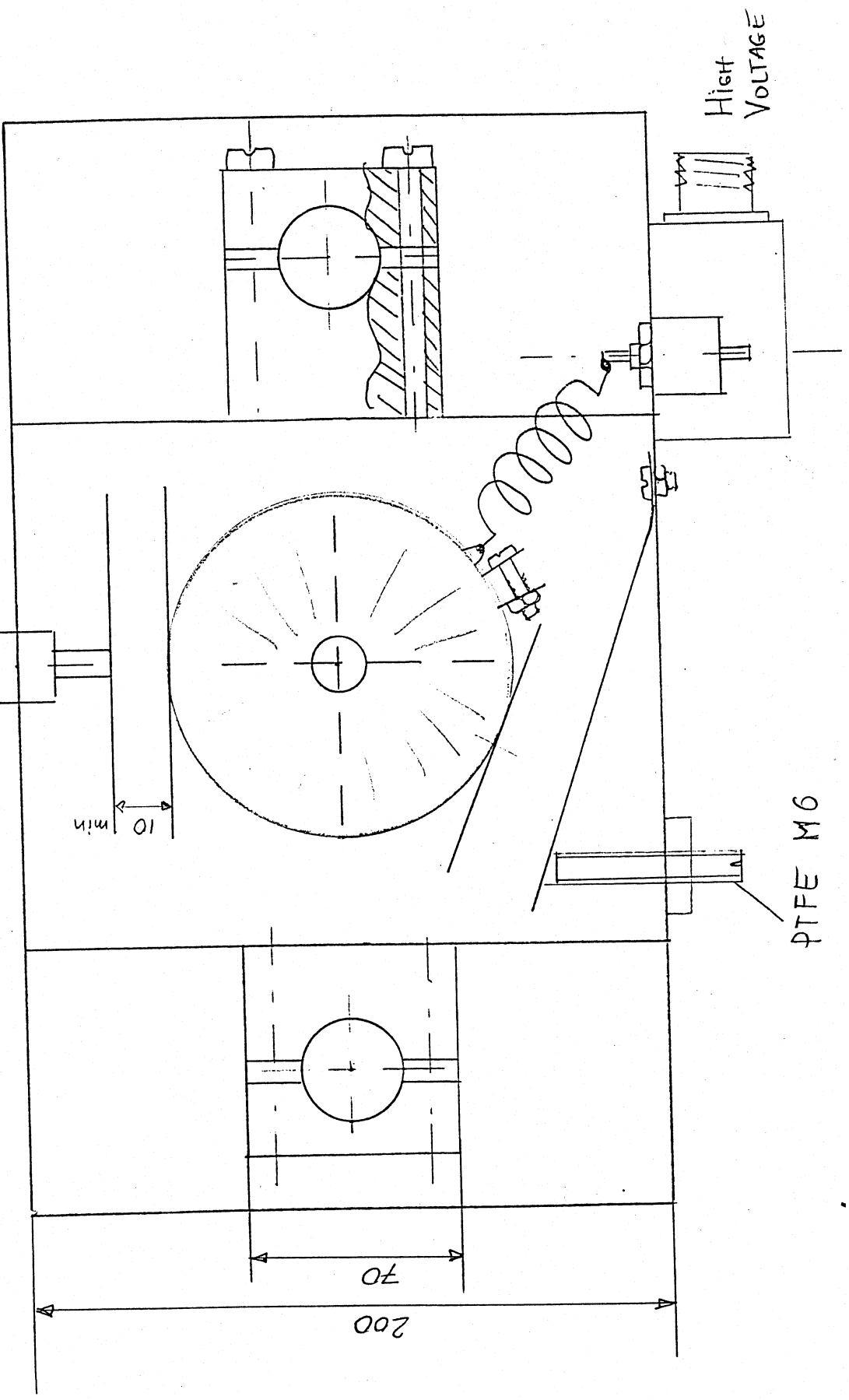

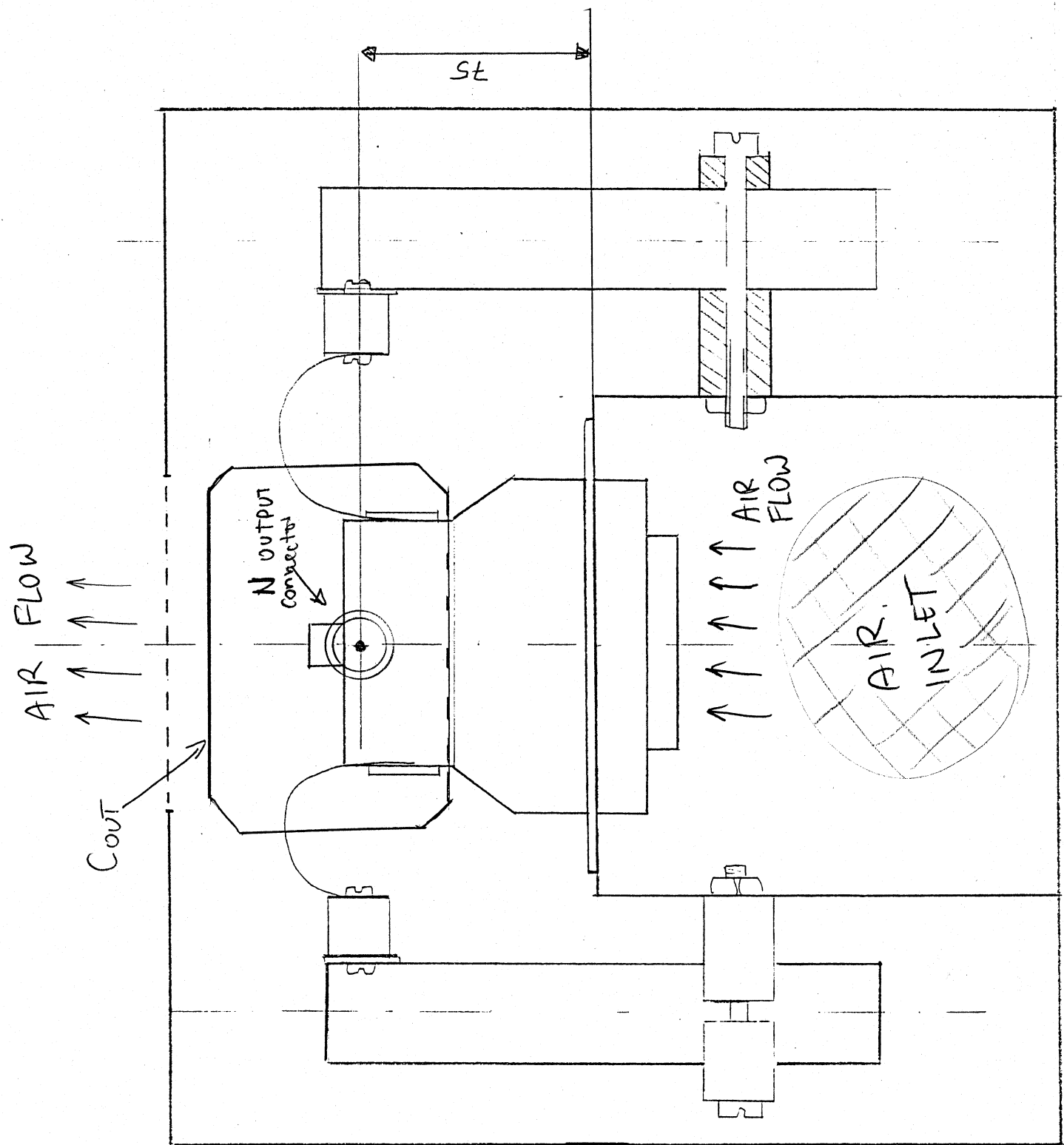

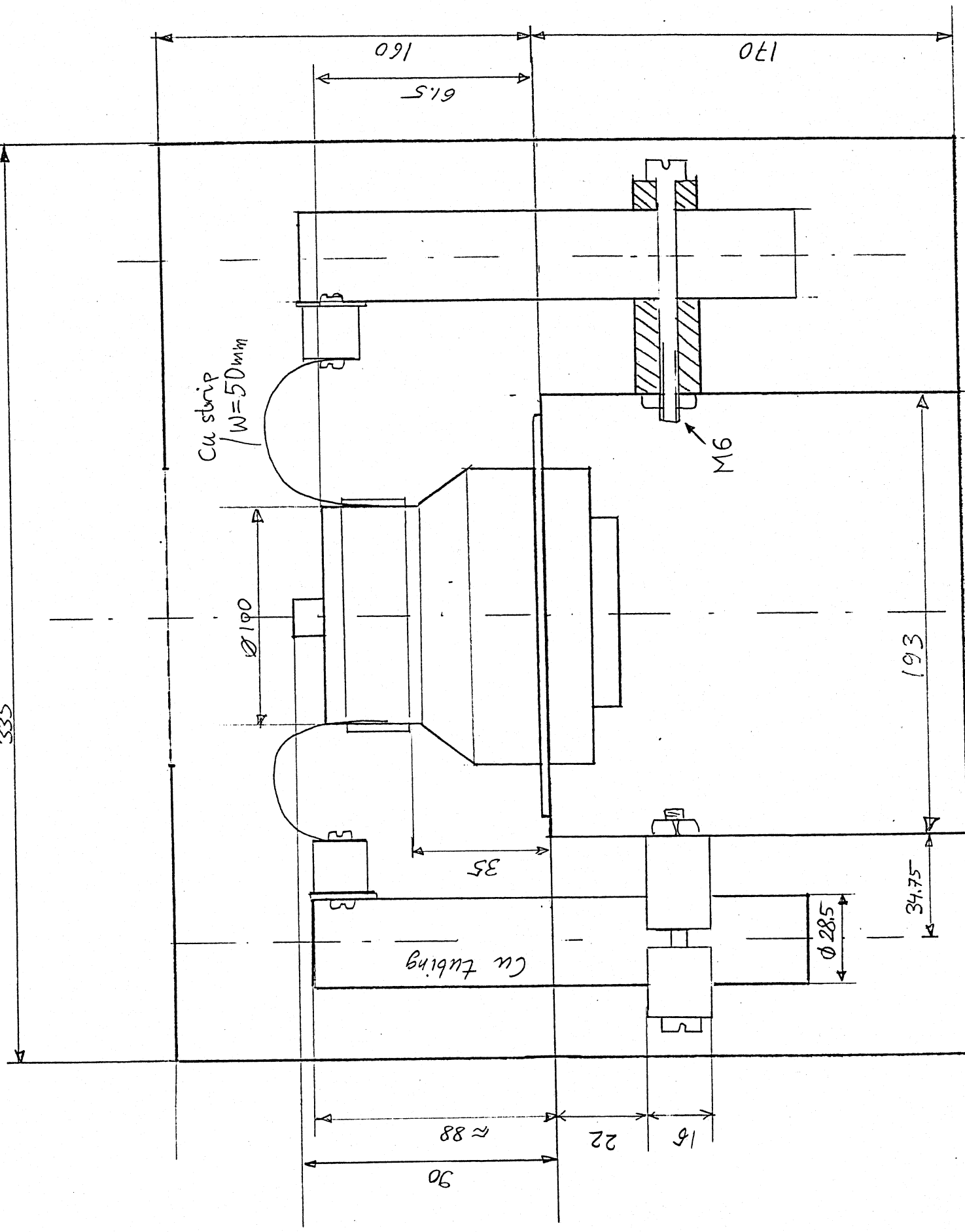

Cu strip
/ W=50mm

$\phi 100$

Cu tubing

$\phi 28.5$

M6

170

160

61.5

193

34.75

90

≈ 88

22

15

from: 99-09-21

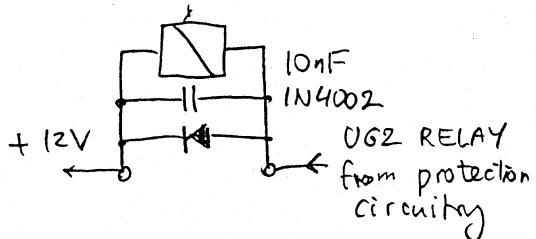
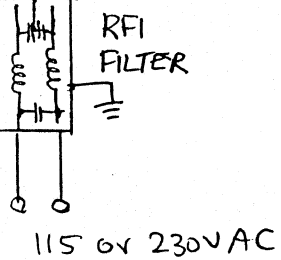
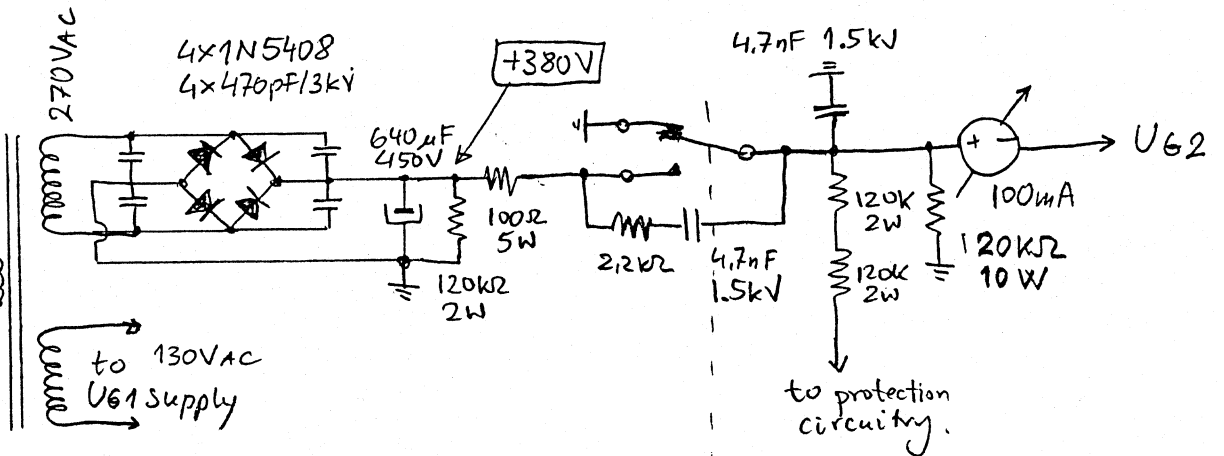
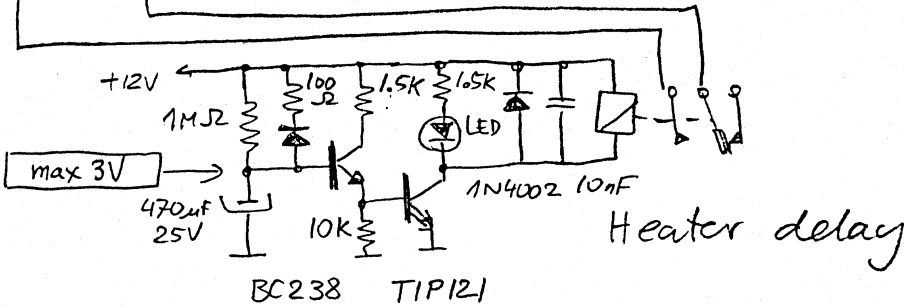
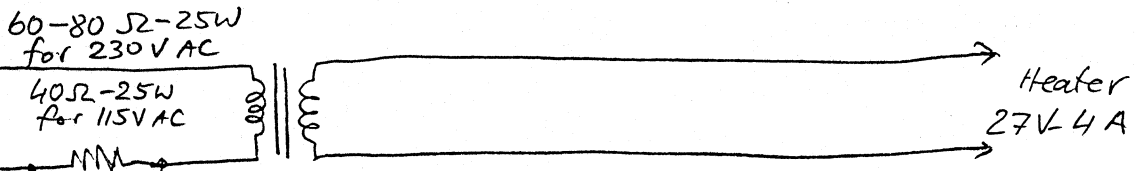
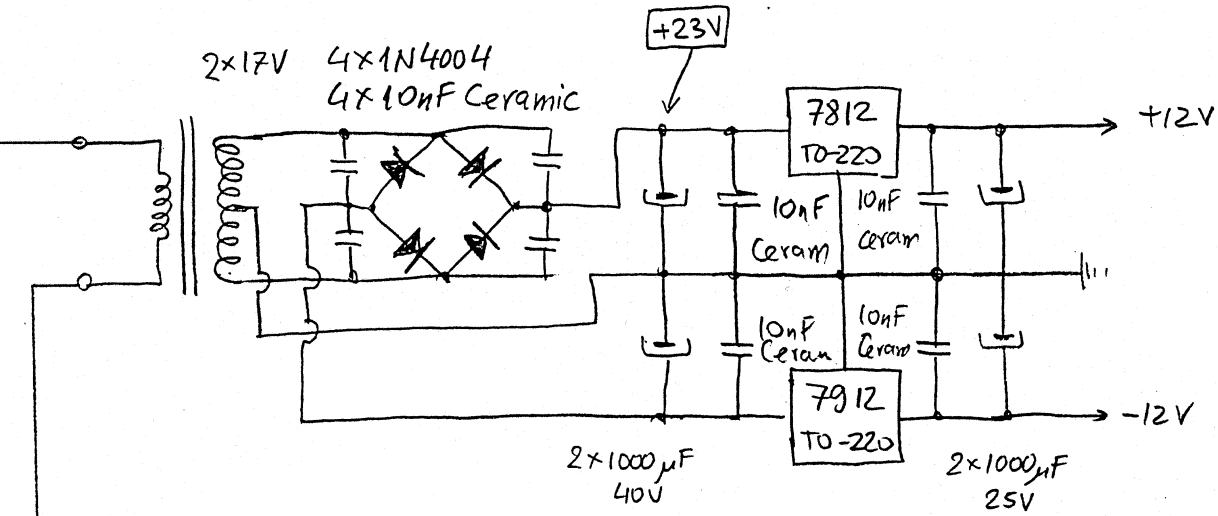

GRID1 voltage regulator and switch Paul Chomiński WAGPY

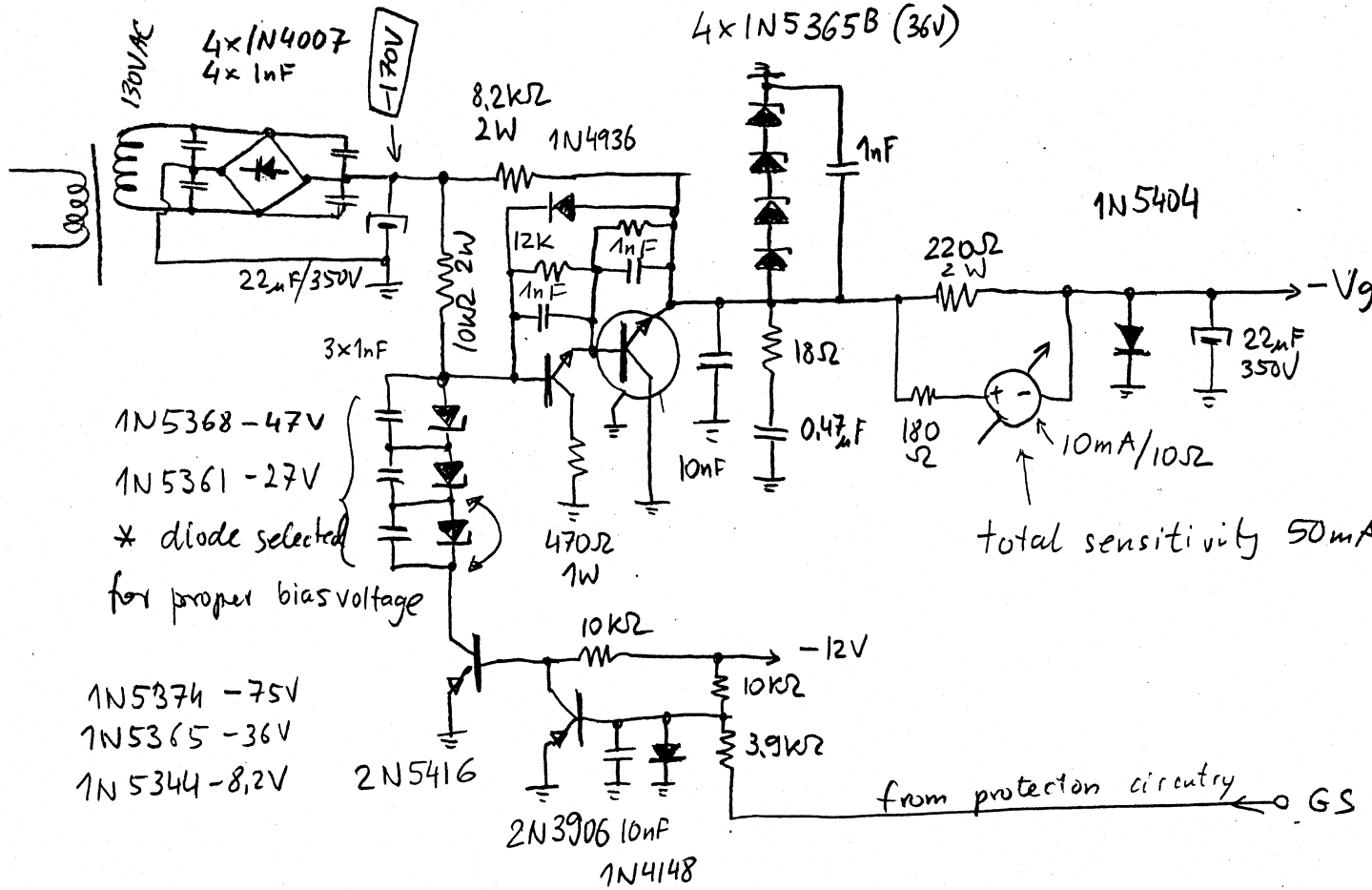

Output power has been measured through low pass filter in order to eliminate power of harmonic signals from measurement. Measured losses of that low pass filter are 0.09 dB what is equal to 2.09%. Power was measured by means of directional coupler, 10 dB attenuator and HPE4418B power meter with HP-E9301A Power Sensor. Coupling factor of the directional coupler, attenuator, connecting cable, and low pass filter losses were measured by means of HP-8753D Network Analyzer.

Accuracy of the power measurements:

Measurement of : Directional Coupler + Attenuator + cable loss = +/- 0.5 dB

Accuracy of the Power meter = +/- 0.5 dB

Total accuracy = +/- 1 dB what is +/- 25.9 %

Parameter			Units
Ua loaded	1700	1700	V
Iao	50	50	mA
Iam	1750	2100	mA
Vg1	-79	-86	V
Vg2	300	364	V
Ig1	10	20	mA
Ig2	50	50	mA
Pa DC input	2975	3570	W
Pa dissipation	1391.523	1811.942	W
Pin RF	62	65	W
Pout with LPF	1551	1722	W
Pout without LPF	1583.477	1758.058	W
Gain	25.53995	27.04704	W/W
Gain [dB]	14.0722	14.3212	dB
Efficiency	53.22612	49.24532	%
Assuming total power measurement error +/- 1 dB			
Min Pout with LPF	1149.407	1276.13	W
Max Pout with LPF	1952.593	2167.87	W
Min Pout without LPF	1173.475	1302.852	W
Max Pout without LPF	1993.48	2213.264	W
Min Efficiency	39.44453	36.49445	%
Max Efficiency	67.00772	61.99618	%

9. Bibliography

1. Eimac Amateur Service Newsletter – W6SAI AS-47 Aug 22, 1971
High Performance 144 MHz Power Amplifier

Also available at: <http://web.wt.net/~w5un/8877-1.htm>

2. SM5BSZ series available at: <http://ham.te.hik.se/~sm5bsz/>

3. Mark de Muck ON5FF, 144 MHz High Power Amplifier, DUBUS 3/1985

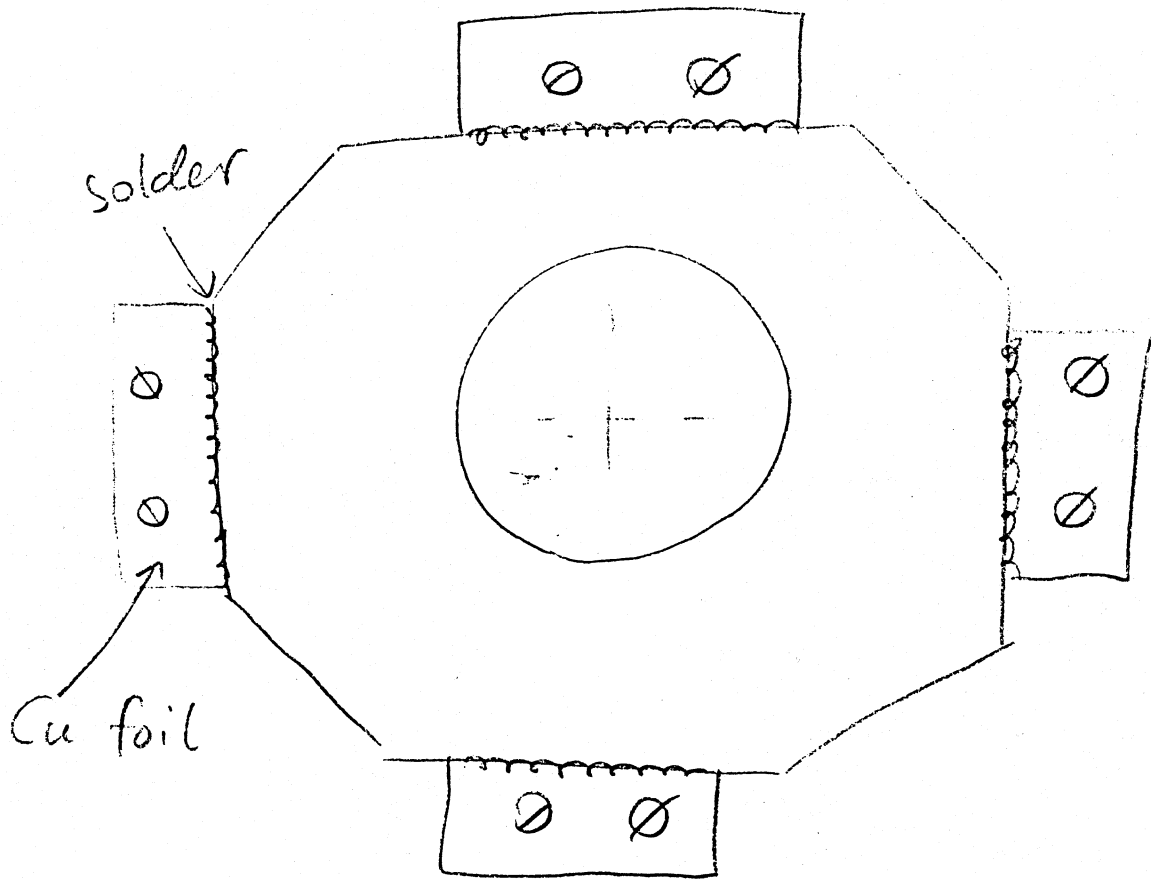
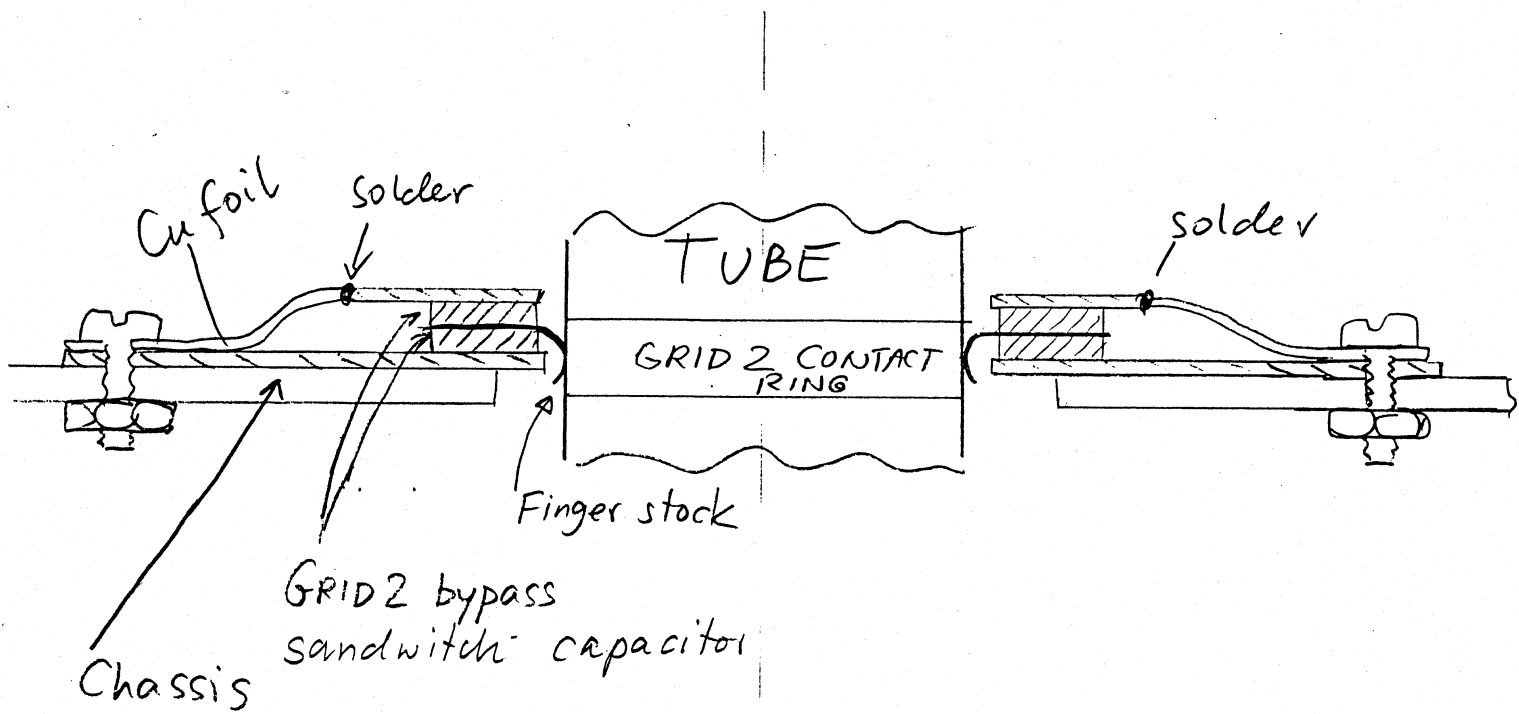
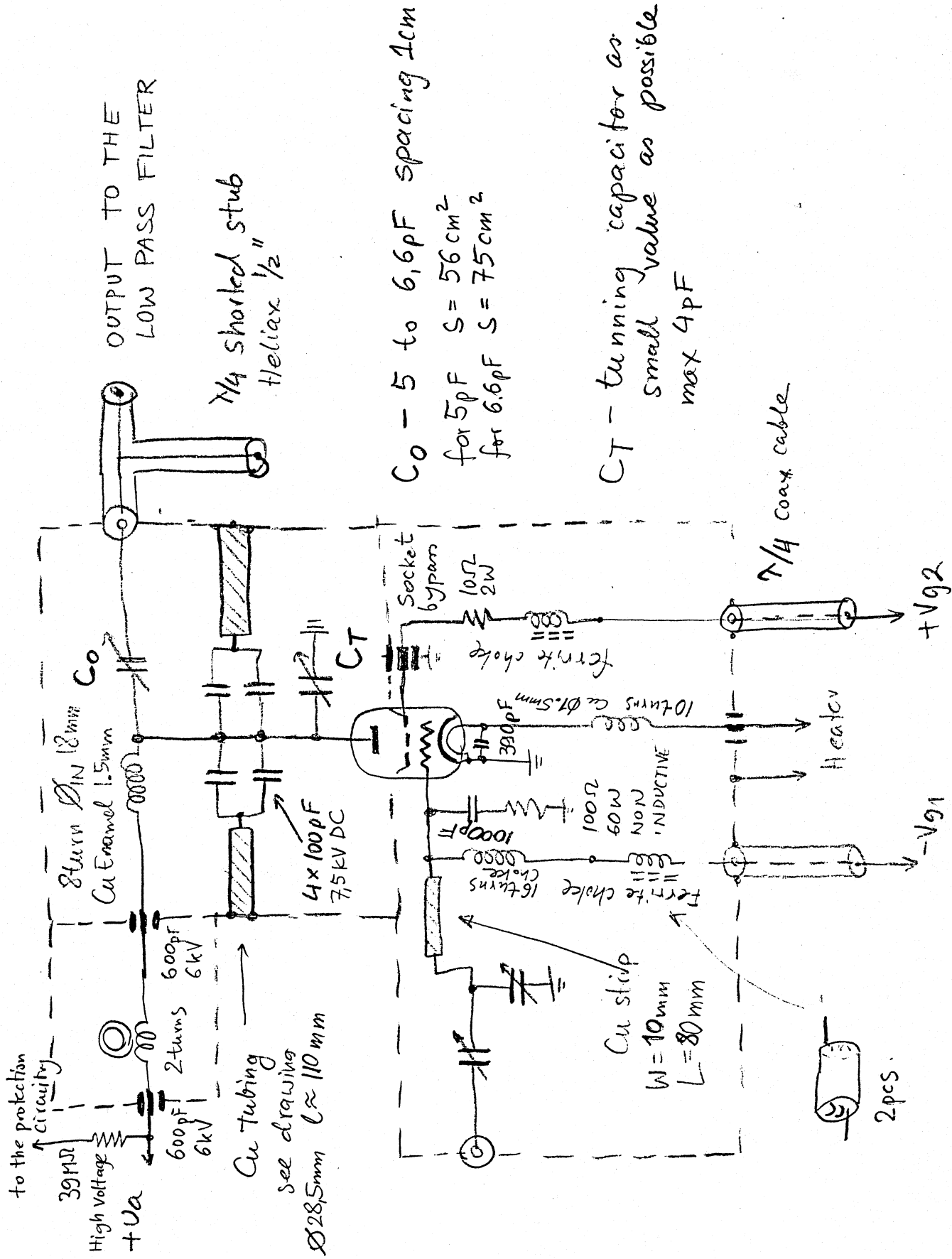

FIG 1. Modification of original tube socket



OUTPUT TO THE LOW PASS FILTER

1/4 shorted stub Heliax 1/2"

$C_0 - 5$ to 6.6pF spacing 1cm
 for 5pF $S = 56\text{cm}^2$
 for 6.6pF $S = 75\text{cm}^2$

CT - tuning capacitor as small value as possible max 4pF